

SM-ALL



COMPLETE LINE OF AMPLIFIED SUBMINIATURE PHOTOELECTRIC SENSORS

- 15mm, 20mm, 30mm and 50mm fixed focus proximity
- 1,5m retroreflective and 1m polarized retroreflective
- 2m through beam models
- Amplified NPN or PNP output with NO-NC output

APPLICATIONS

- Processing and Packaging machinery
- Automotive
- Beverage & Bottling
- Vending machines



SM-ALL		
Through beam	0...2 m	
Retroreflective (on R2 reflector)	0,05...1,5 m	
Polarized retroreflective	0,1...1 m	
Fixed focus	3...15 mm	
	3...20 mm	
	3...30 mm	
	3...50 mm	
Power supply	Vdc	10...30 V
	Vac	
	Vac/dc	
Output	PNP	•
	NPN	•
	NPN/PNP	
	relay	
	other	
Connection	cable	•
	connector	
	pig-tail	
Approximate dimensions (mm)	8x23x12	
Housing material	Polycarbonate	
Mechanical protection	IP67	

CONNECTIONS

INDICATORS AND SETTINGS

CABLE

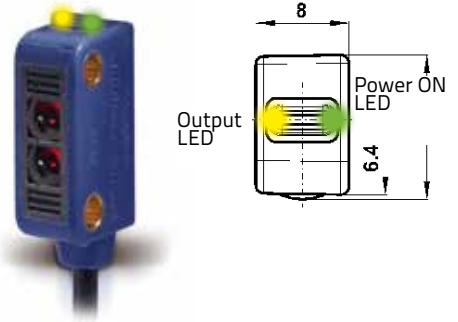
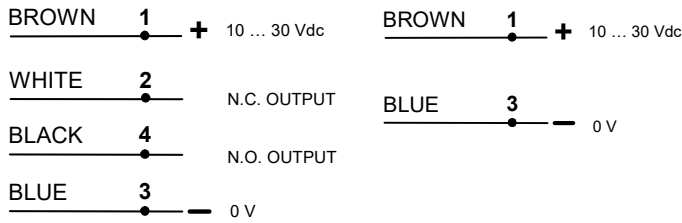

DETECTIONS DIAGRAMS

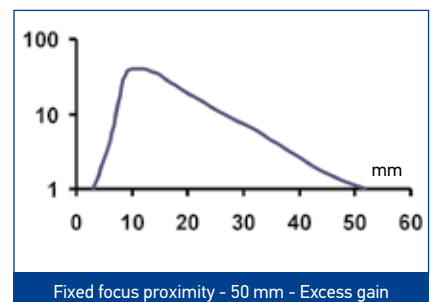
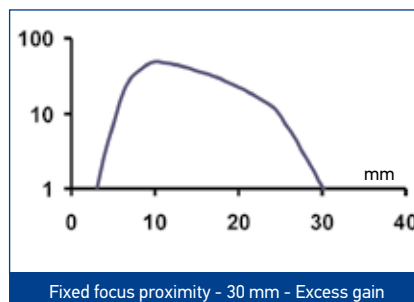
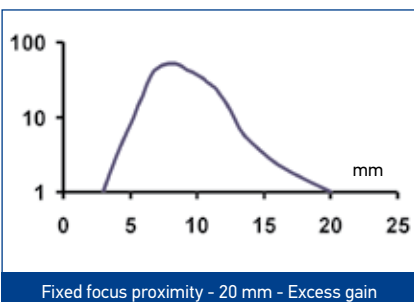
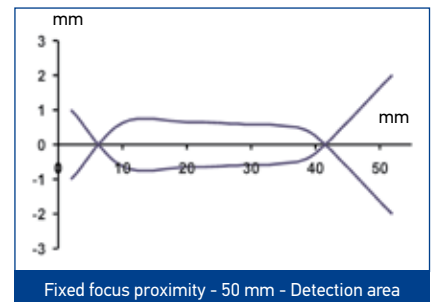
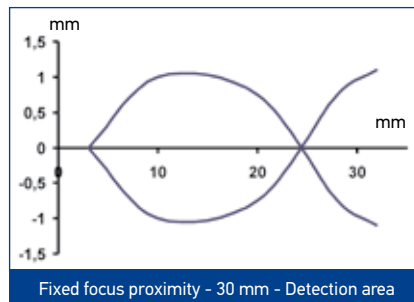
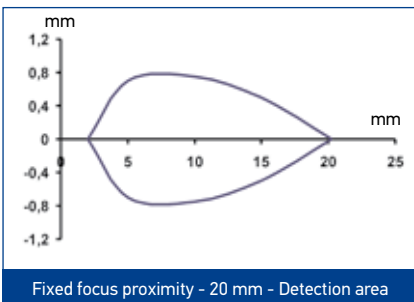
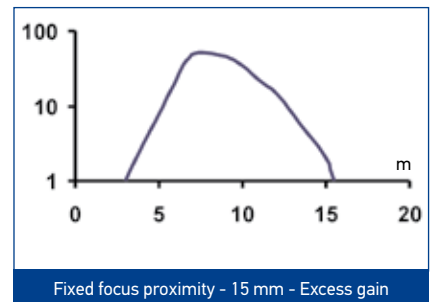
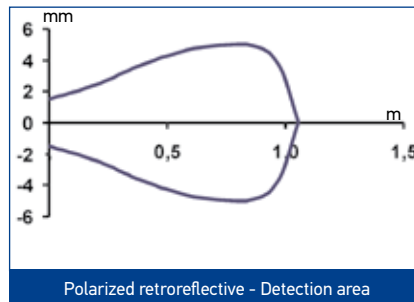
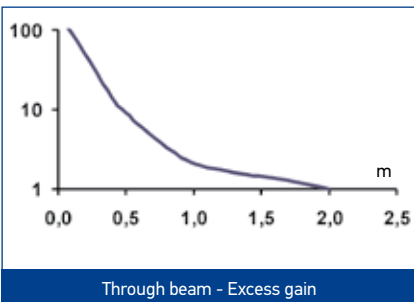
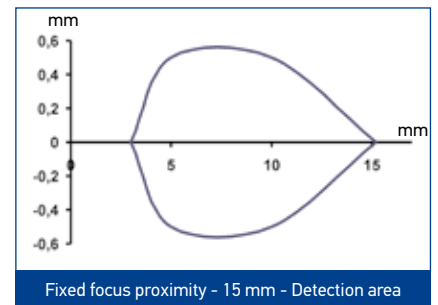
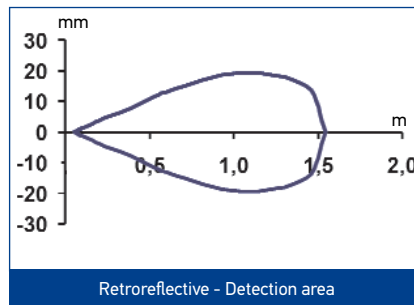
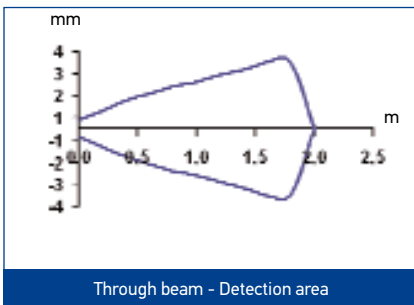

MODEL SELECTION AND ORDER INFORMATION

OPTIC FUNCTION	OPERATING DISTANCE	CONNECTION	OUTPUT	MODEL	ORDER No.	
Retroreflective	0,05...1,5 m	2m Cable	PNP	SM-PR-2-A00-PP	95B000060	
			NPN	SM-PR-2-A00-NN	95B000070	
Polarized retroreflective	0,1...1 m	2m Cable	PNP	SM-PR-2-B00-PP	95B000080	
			NPN	SM-PR-2-B00-NN	95B000090	
Fixed focus (short distance)	15 mm	2m Cable	PNP	SM-PR-2-D00-PP	95B000020	
			NPN	SM-PR-2-D00-NN	95B000030	
Fixed focus (normal distance)	20 mm		PNP	SM-PR-2-D10-PP	95B000140	
			NPN	SM-PR-2-D10-NN	95B000150	
Fixed focus (medium distance)	30 mm		PNP	SM-PR-2-D20-PP	95B000040	
			NPN	SM-PR-2-D20-NN	95B000050	
Fixed focus (long distance)	50 mm		PNP	SM-PR-2-D30-PP	95B000000	
			NPN	SM-PR-2-D30-NN	95B000010	
Through beam receiver	0...2 m		2m Cable	PNP	SM-PR-2-F00-PP	95B000120
				NPN	SM-PR-2-F00-NN	95B000130
		-		SM-PR-2-G00-XG	95B000160	

ACCESSORIES

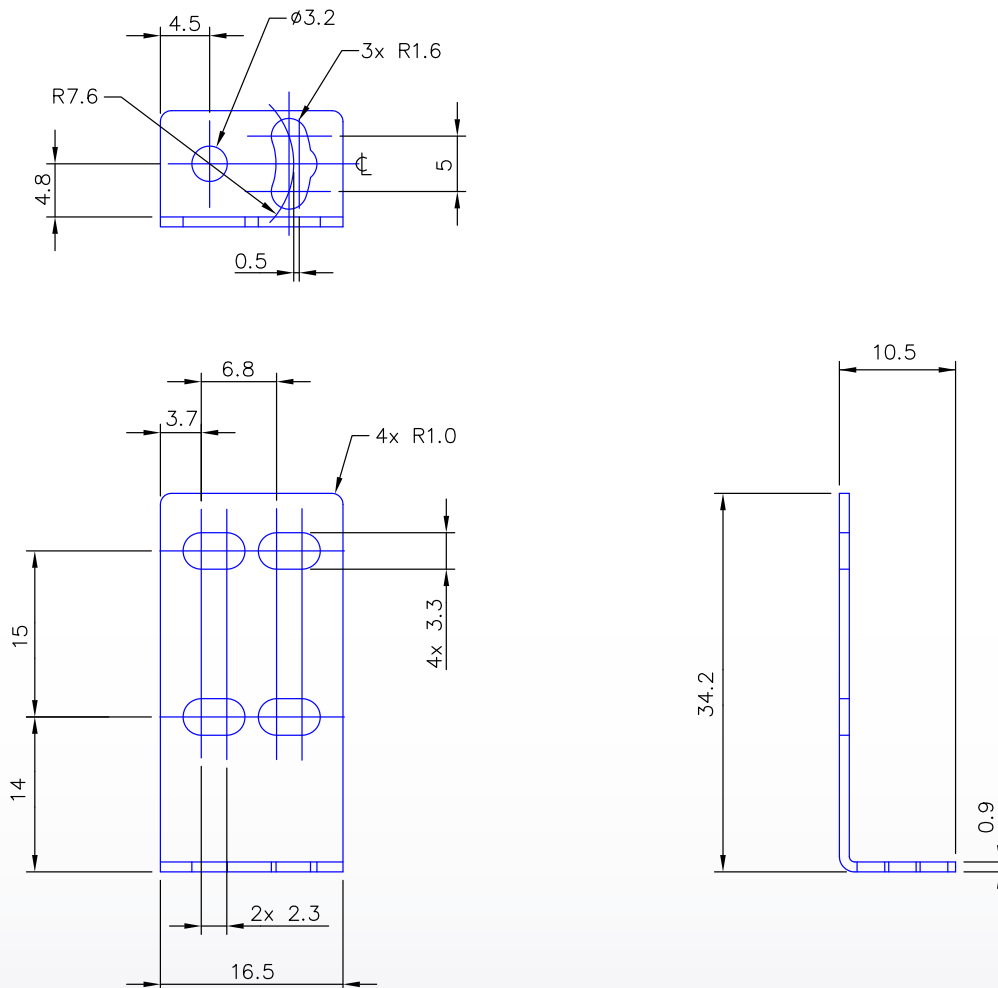

MODEL	DESCRIPTION	ORDER NO.
ST-5049	right angle bracket	95ACC6650